

SINCE 1988~

정밀·절삭·가공 기업  
www.joongil.com

# JOONG IL TECH

(주)중일테크



www.joongil.com



AUTOMOBILE  
ELECTRONIC COMPONENT  
SPECIAL PROCESSING  
RFTELECOMMUNICATIONS  
COAXIAL CONNECTORS  
CABLE ASS'Y  
MILITARY COMMUNICATIONS EQUIPMENT  
CAMPING  
MEDICAL INSTRUMENT  
SPRAY NOZZLE

HIGH TECHNOLOGY & QUALITY

 (주)중일테크  
SINCE 1988~ JOONG IL TECH CO., LTD.

경기도 김포시 대곶면 대곶북로 91-42  
TEL 031.988.2811 FAX 031.988.2821  
제품문의 : sales@joongil.com

 [blog.naver.com/joongil2810](http://blog.naver.com/joongil2810)

Start with the  
**best goals,**  
We're running toward  
**each other.**

주식회사 중일테크는  
최고의 목표를 기점으로  
상생하며 달려가고 있습니다.

▶ 조직도



## CONTENTS

회사연혁(History)	04
인증서(Certificate)	06
생산1팀(CNC)	08
생산2팀(CAM 자동선반)	10
생산3팀(RF CONNECTOR Assembly)	12
품질경영팀(Quality)	14
자동차   KEY	16
정밀가공	17
방산	18
특수가공   INSERT	19
캠핑	20
의료기기   분사노즐	21
SWITCH CONNECTOR	22
CONNECTOR   POWER CONNECTOR	23
CABLE ASS'Y   ADAPTOR	24

# HISTORY

PROFESSIONAL QUALITY

· 1988. 10 중일금속 설립



## Start 1990~1999

- 1993
  - 12 · Sensor Poket 개발
  - 10 · Air Pin 질소주입구 개발
  - 04 · 방위산업체 한국화학(주) 국방규격 국방0050-0008 K3 뇌관몸체 개발

## JOONG 2000~2008

- 2008
  - 05 · MMCX SWITCHING CONNECTOR 개발
- 2007
  - 05 · (주)중일테크' 인천지점 설립 (인천 서구 당하동)
- 2006
  - 12 · 벤처기업 및 이노비즈 인증
  - 07 · (주)파트론 협력사 등록 S/W 및 RF CONNECTOR 공급
- 2005
  - 11 · DMB · 네비게이션 용 유리흡착형 4", 7" 거치대 개발
  - 08 · DMB용 SWITCH CONNECTOR용 LOCKING TYPE 개발
- 2004
  - 09 · ISO 9001:2000 / KSA 9001:2001 취득
  - PCB MOUNT TYPE SMB CONNECTOR 중국 · 대만 수출
  - 01 · PCB MOUNT TYPE SMB CONNECTOR 중국, 대만 수출
- 2003
  - 11 · 차량용 TV 거치대 개발
  - 01 · (주)리텍 무선진동벨 단자 공급 체결
- 2000
  - 07 · 방위산업체 한국화학(주)

## 회사연혁

주식회사 중일테크의 역사와 함께한 발자취를 소개합니다.

## TECH 2013~2021

- 2021
  - 08 · (주)경신 협력사 등록
- 2020
  - 05 · KT&G 2차 협력사 등록 (주)이랜텍 전자담배 HEATER SHAFT 공급
  - 02 · 5G 광통신부품(경통) 공급
- 2018
  - 08 · 방위산업업체 1차 협력사 등록 (풍산 FNS, 연합정밀)
  - 01 · 품질경영 시스템 인증서 인증 TS16949 => IATF 16949 : 2016 인증
- 2016
  - 04 · LG 디스플레이 2차 협력업체 등록 PAN NUT 공급
- 2015
  - 09 · 수출항 농약 분사 SPRAY NOZZLE 개발, 특허등록
- 2014
  - 12 · 캠핑용품 생산 공급 (가스밸브 및 어댑터)
  - 11 · (주)에이스테크놀로지 차량 안테나용 INSERT 공급계약
  - 08 · (주)위너콤[휴맥스] 차량 샤크 안테나용 SMB CONNECTOR 및 INSERT 공급계약
  - 03 · 세방전지(주) 1차 협력사 등록 배터리 전극단자 공급

## IL 2009~2013

- 2013
  - 10 · ISO/TS 16949:2009 품질 경영 체제 인증
  - 08 · 환경 경영 체제 인증 ISO 14001
  - 07 · (주)아모텍 협력업체 등록 패치안테나 PIN 공급
  - 05 · SK텔레콤 2차 협력사 등록 기지국용 CONNECTOR 공급
  - 04 · 본사 · 인천지점 통합 및 확장이전 (현 위치 : 김포시 대곶면)
  - 01 · 품질경영 시스템 인증 ISO/TS 16949:2009
- 2012
  - 12 · 텅크웨어(아이나비)' 2차 협력업체 등록
- 2010
  - 12 · (주)현대케피코' 2차 협력업체 등록 / 스피드센서 BUSH 공급
  - 04 · 르노삼성자동차 하이패스용 RG CONNECOR 및 CABLE ASS'Y 공급
  - 02 · (주)현대케피코' 2차 협력업체 등록
- 2009
  - 05 · 기업부설연구소 설립인증

# start for Better Future and Better World Birth of **JOONG IL TECH**

더 나은 미래, 더 좋은 세상을  
만들기 위한 시작  
**(주)중일테크**



(주)중일테크  
**JOONG IL TECH**

## CERTIFICATE

인증서



IATF 16949



ISO 9001



ISO 14001

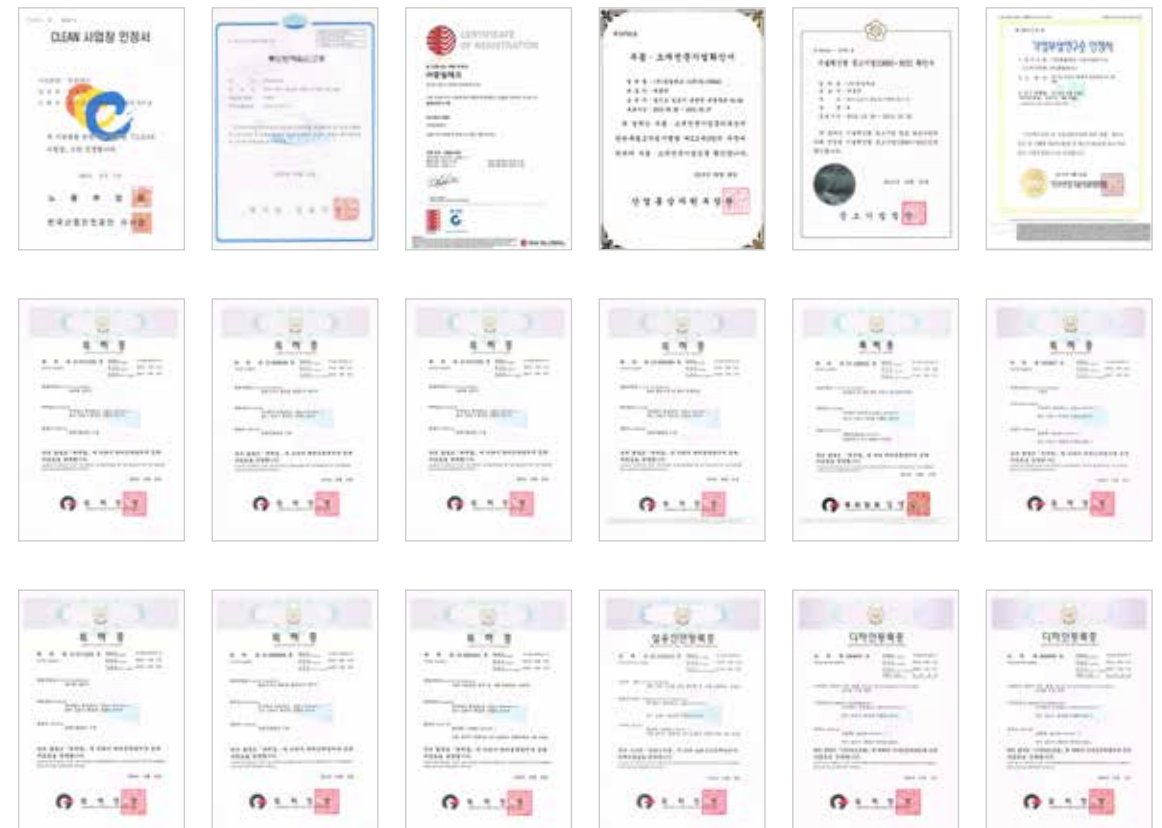

# CNC

## 생산1팀(CNC)

최신 설비와 기술력을 보유

## 90여대의 CNC 복합라인

고객의 제품에 정밀가공으로 보답하고, 자동차 부품 가공용 CNC 복합기를 지정하여 공정검사 시행 중에 있으며, 최신 설비에 적극적인 투자를 하고 있다.

각 설비 별 측정 GAUGE 및 공구현미경을 비치하여 이상 발견 시 즉시 조치.



CHIAH CHYCN

52형 : 3대



TSUGAMI

3형 : 2대 | 10형 : 7대 | 12형 : 3대  
20형 : 8대 | 32형 : 1대



CINCOM

20형 : 2대



CHIAH CHYCN

36형 : 12대



QUICK-TECH

42형

STAR

10형 : 13대 | 12형 : 8대 | 20형 : 7대



HANHWA

20형 : 7대 | 32형 : 1대 | 38형 : 2대



HWACHEON

48형



WIA

50형



DAEWO

49형

### CNC Turret lathe

# CAM

생산2팀(CAM 자동선반)

후가공 LINE

100여대의 자동선반 라인

공정을 정하고, 계산된 생산 회전수와 비 생산 각도에 의해 각각의 생산 각도를 산출, 안분하여 만들어진 캠(CAM)에 의해 자동으로 연속 가공이 이루어지는 형식으로, 단품위주의 가공품을 생산하고 있습니다.

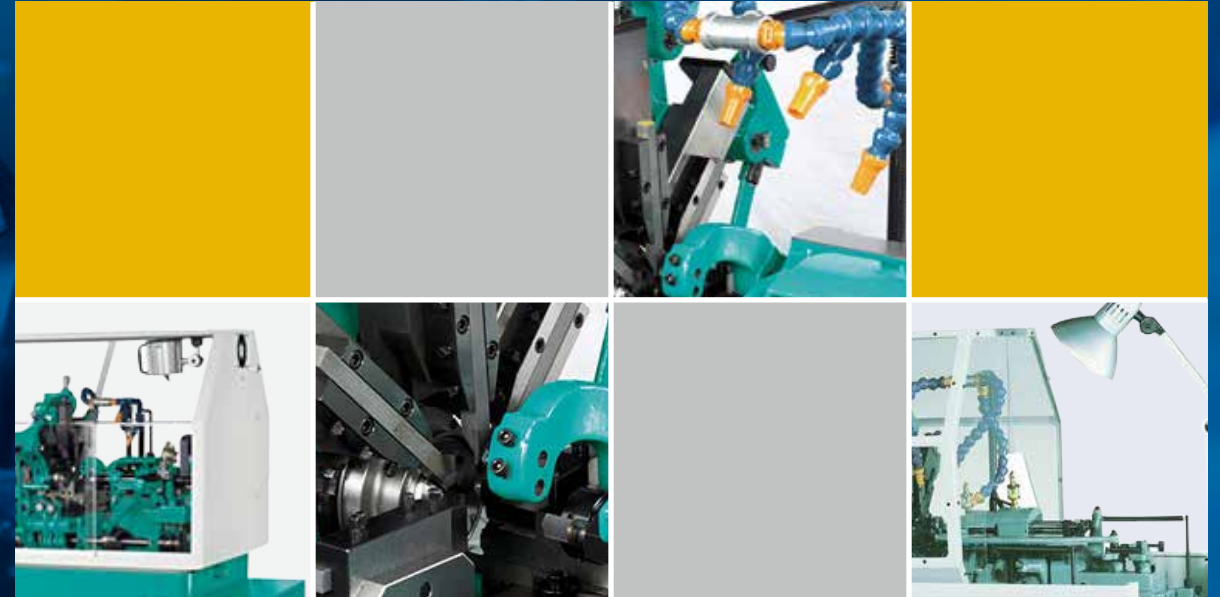

## (주)중일테크는

끊임없는 연구개발과 기술축적을 통해 RF를 주도하는 젊은 기업입니다.

## Joong Il Tech CO., LTD.

Through constant research and development and technology accumulation, It's a young company that leads RF.



# RF

생산3팀  
(RF CONNECTOR Assembly)

케이블 조립체

## CABLE ASSEMBLY

CABLE ASSEMBLY 등의 각 공정별 조립되는 소재와 작업 특성에 맞는 최신의 설비와 기술을 도입하여, 작업자의 안전과 생산성 향상 및 고품질의 제품을 생산하고 있습니다.

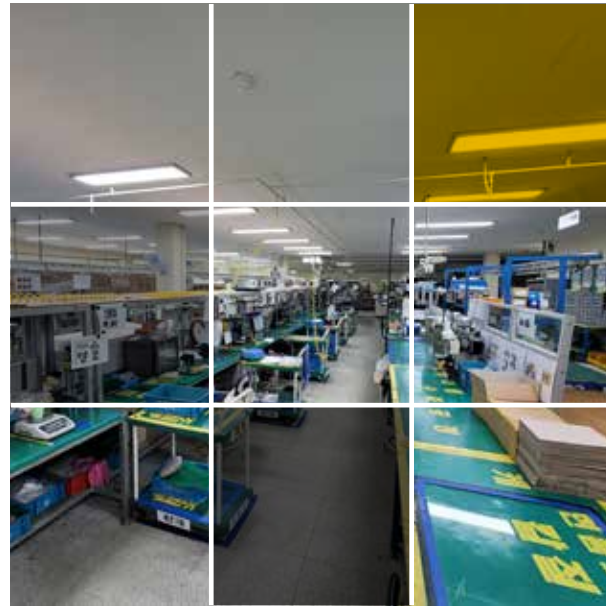

**ACB-30**  
3차원 자동밴딩기



**lazer marking**  
machine



**내전압측정기**



**무소음 압착기**



**에어프레스**



**공압프레스**



**네트워크 분석기**



**DMT-2000 테이핑머신**



**코킹 자동화설비**



**인라인 탈피기 스위스**



**Coaxial 탈피기**

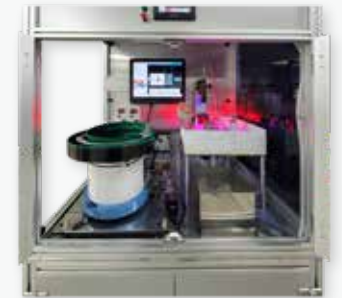

**형상치수비전기**

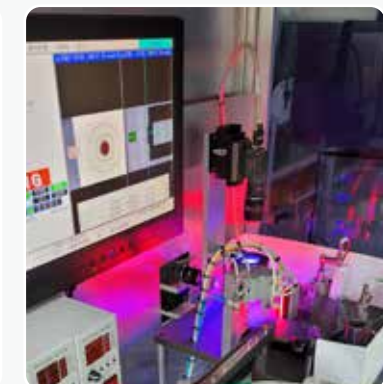

# QUALITY

품질경영팀  
(완제품 품질관리)

Professional quality

## JOONG IL TECH

고객의 **신뢰**와 **만족**을  
얻기 위하여  
항상 **고품질**을  
지향합니다.



3D Mitutoyo  
QUICK VISION ELF



2D 공구 현미경  
1대 | 4대



Mitutoyo  
SJ-410 표면조도 측정기



Mitutoyo  
MF 측정기

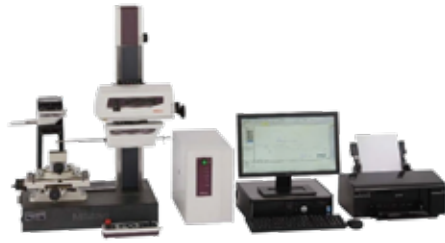

조도/형상측정기  
2대



각종 치수별 측정 게이지

## INSERT & PIN VISION SYSTEM

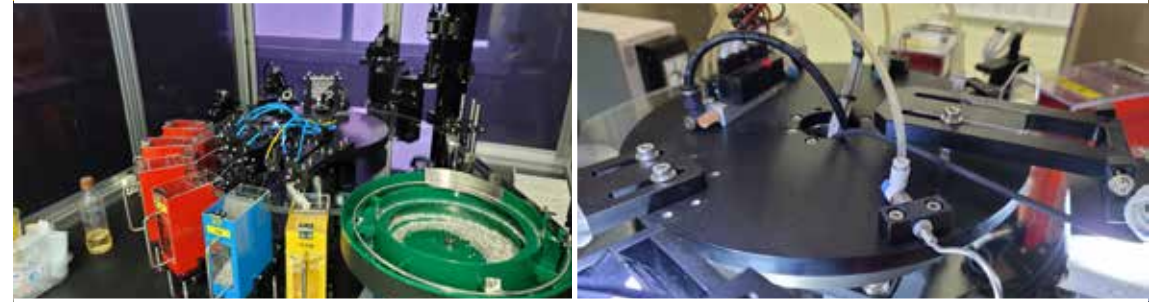

## NUT Automatic Feeder SYSTEM



# 자동차 AUTOMOBILE

# 정밀가공 METAL PROCESSING



# KEY



## 방산 MILITARY



## 특수가공 SPECIAL METAL PROCESSING



## INSERT



# 캠핑 CAMPING

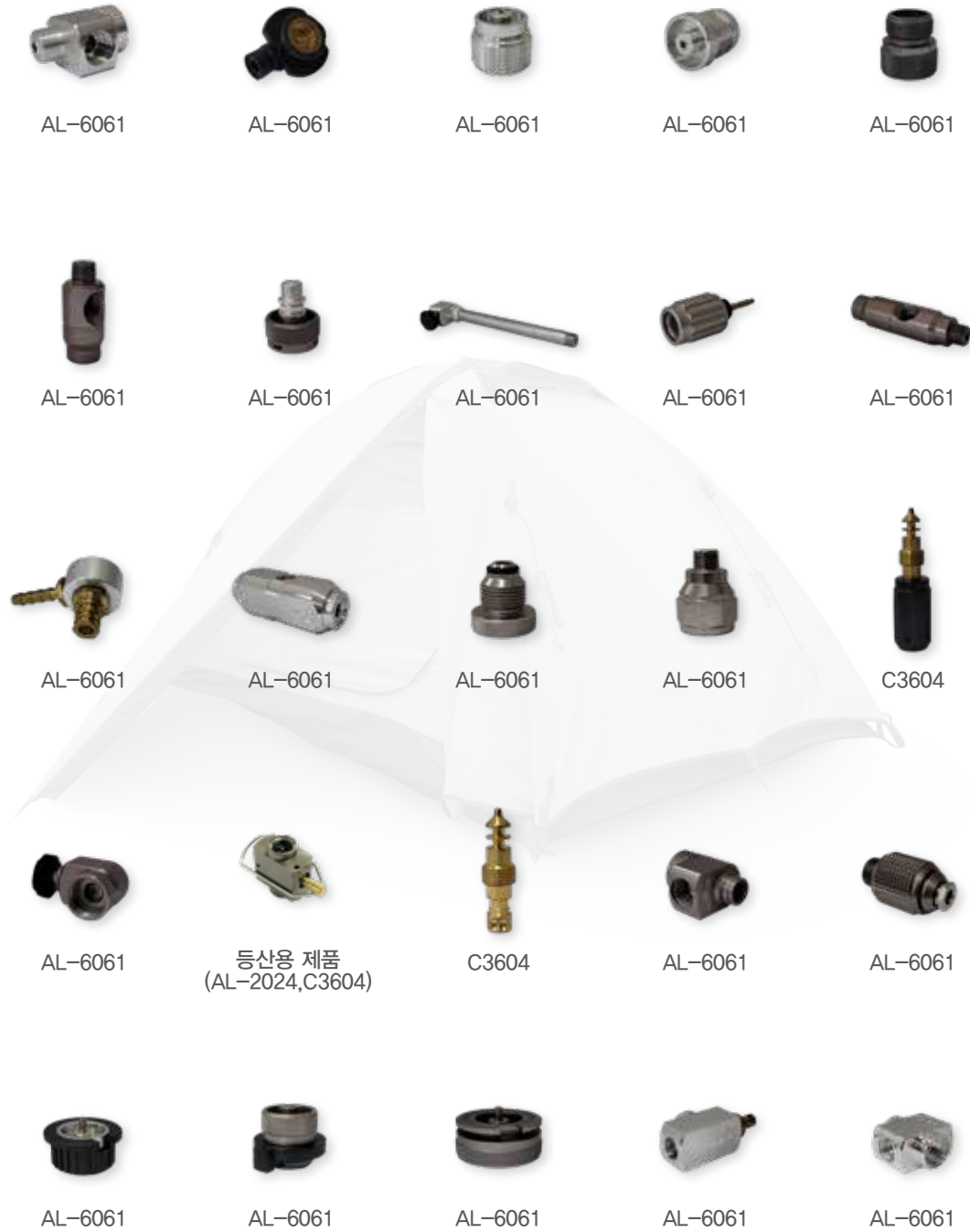

# 의료기기 MEDICAL INSTRUMENT



# 분사노즐 SPRAY NOZZLE

특허 출원(10-2015-0127722, 10-2015-0127725)

농약 또는 물등의 액체를 공급하는데 사용되는 분무기 노즐 (노즐에서 분사 되는 액체를 직선또는 원추형 상태로 조절)

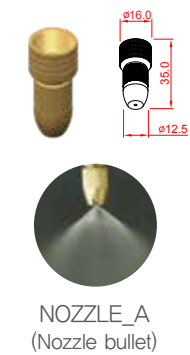
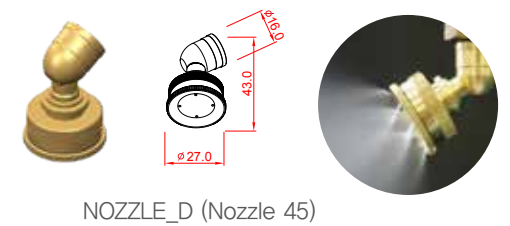

# SWITCH CONNECTOR

- SMD ( SURFACE MOUNTED DEVICE) 부품이며, 무연솔더링 SMD도 가능하다.
- 상대물 결합 전은 PIN(A), (B)의 도통 상태이며, 상대물 결합 후는 상대물 MALE PIN과 PIN (B)의 도통 상태로 SWITCHING 구조를 갖는다.
- 차량용 전자전기기에 사용되도록 진동을 흡수할 수 있는 외부 CASE의 2중 결합 방식을 사용 함.



JSCF-2  
(MCX TYPE)



JSCF-3  
(MCX TYPE)

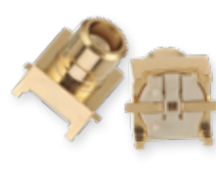

JSCF-4  
(KMS533 TYPE)



JSCF-U  
(MCX TYPE)

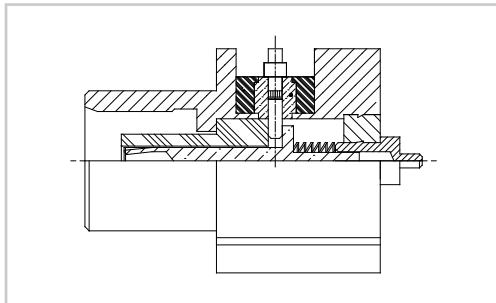

JSCF-5 & JSCF-6  
(MCX straight Side TYPE)



JSCF-3-RV  
(MCX TYPE)

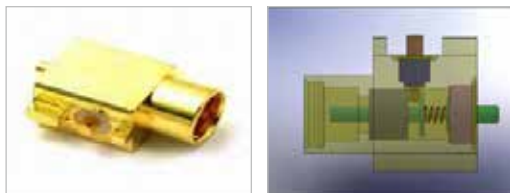

JSCF-9 (MMCX Straight Side TYPE)  
(MMCX CONN. 구조를 응용하여 Switching Jack을 구현)

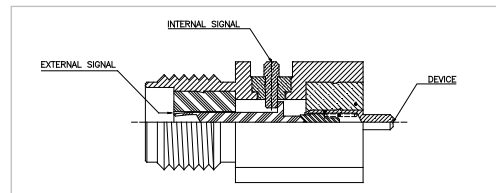

JSCF-7 (SMA straight Side TYPE)  
(SMA CONN. 구조를 응용하여 Switching Jack을 구현)

# CONNECTOR



ATTENUATOR



Base Station CONNECTOR



BNC CONNECTOR



DIN CONNECTOR



F CONNECTOR



N CONNECTOR



MCX CONNECTOR



MMCX CONNECTOR



SMA CONNECTOR



SMB & SMB LOCK CONNECTOR

# POWER CONNECTOR



CONNECTOR ASS'Y



CONNECTOR ASS'Y



OPTIC CONNECTOR



ALRAM CONNECTOR



